

STEERING GEAR

- Removing - refitting 1
- Dismantling - reassembling 3

POWER ASSISTED STEERING BOX

- Removing - refitting 4
- Dismantling - reassembling and checks 8

POWER ASSISTED STEERING

- Composition and operation 9
- Front wheel toe in 11

TIGHTENING TORQUES 12

REMOVING - REFITTING

NOTE *The operations of removing-refitting illustrated refer to the Delta 4WD model. The procedure for the Prisma 4WD is the same.*



P1Q001F01

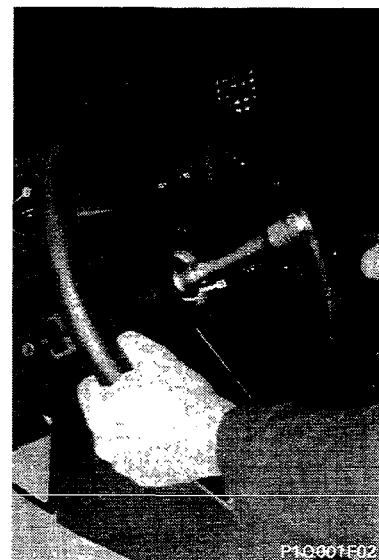

P1Q001F02

Removing-refitting steering wheel

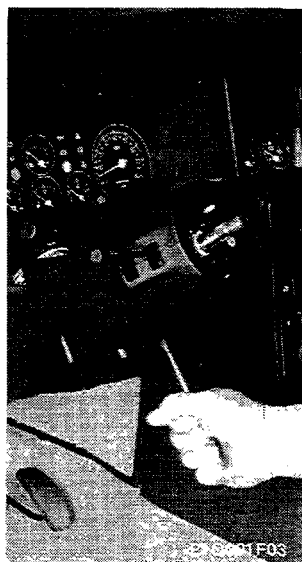

P1Q001F03

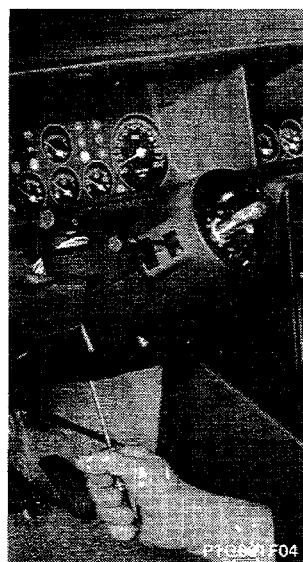

P1Q001F04

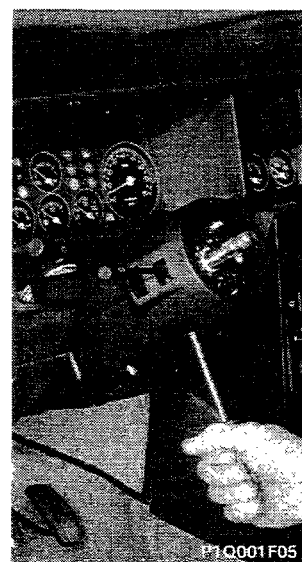

P1Q001F05

Removing-refitting upper shaft shields

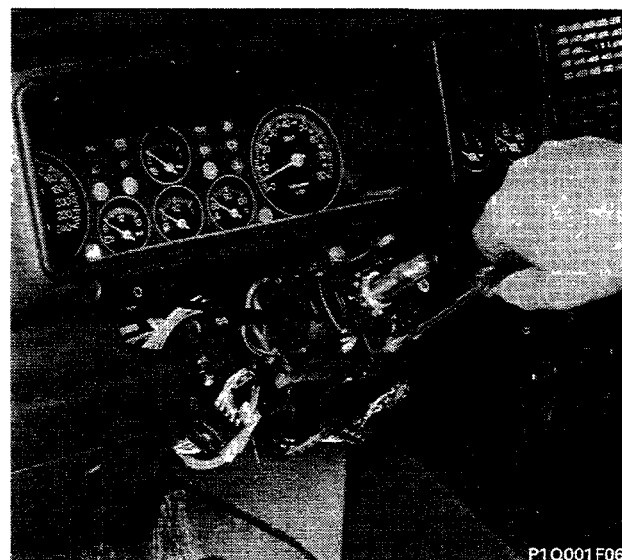

P1Q001F06

Removing-refitting steering column switch unit assembly

NOTE *Disconnect all the electrical connectors from the steering column switch unit.*

41.

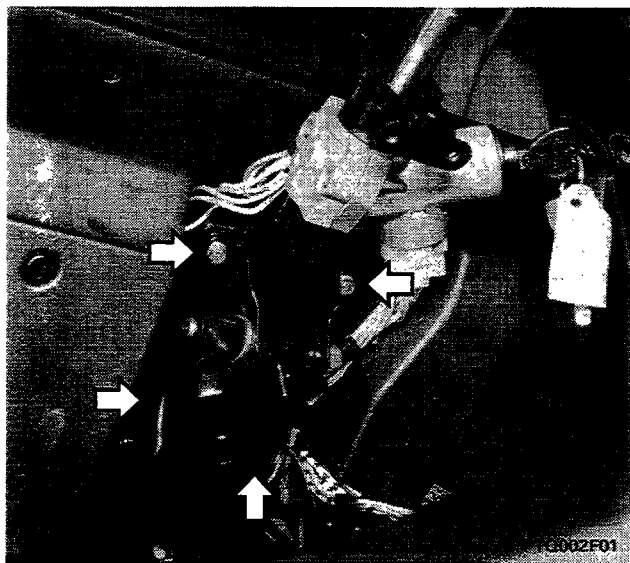

Removing-refitting upper shaft mounting from bodyshell

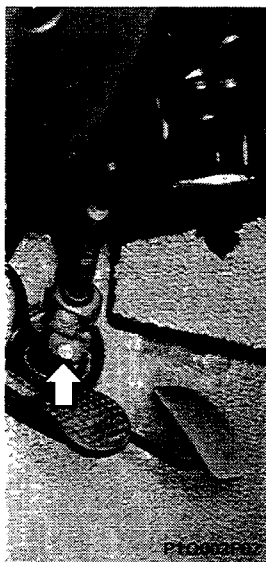

Removing-refitting lower shaft from steering box pinion

NOTE *Lastly, disconnect the upper shaft from the lower one.*

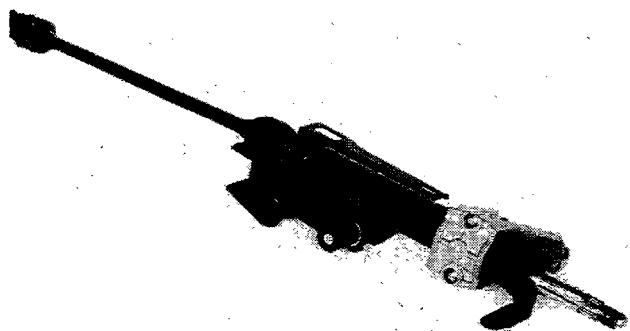

P1Q002F04

Steering gear assembly

DISMANTLING - REASSEMBLING

Dismantling-reassembling steering wheel height adjustment device



Dismantling-reassembling upper shaft from mounting at the bench

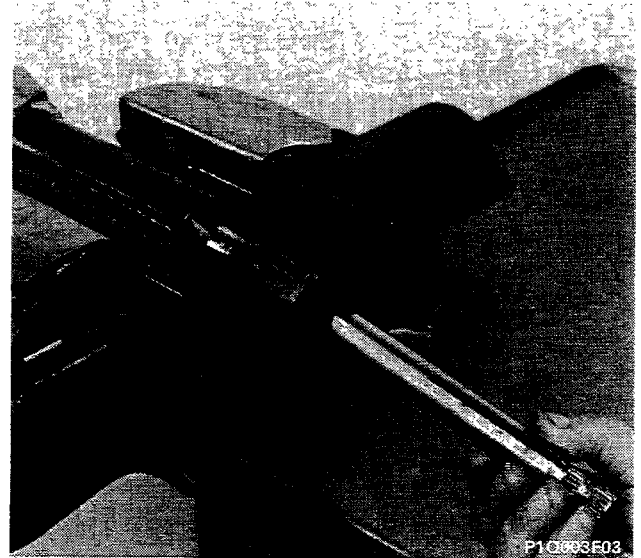

Checking steering gear components

Check that the clearance between the upper steering control shaft and the flexible bushes is not excessive and that the shaft is not off centre. Check that there is not too much clearance in the universal joints for the lower steering control shaft.

If anything seems to be wrong, replace the affected component.

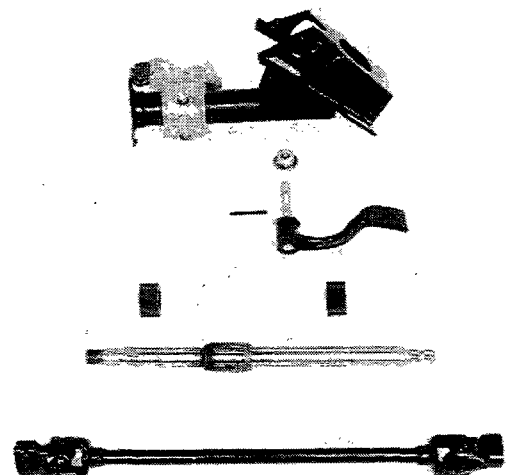

41.

REMOVING-REFITTING

Position the vehicle on a lift.

Then, proceed as follows:

- drain the fluid from the power assisted steering reservoir, in the engine compartment;
- remove the front wheels;
- raise the lift and, from underneath the vehicle, drain the fluid from the idler unit;
- then, remove the items illustrated below:

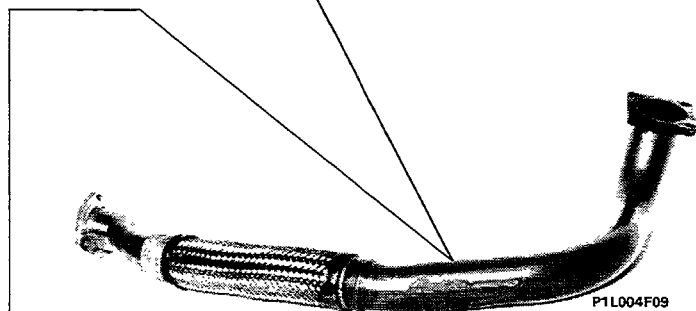
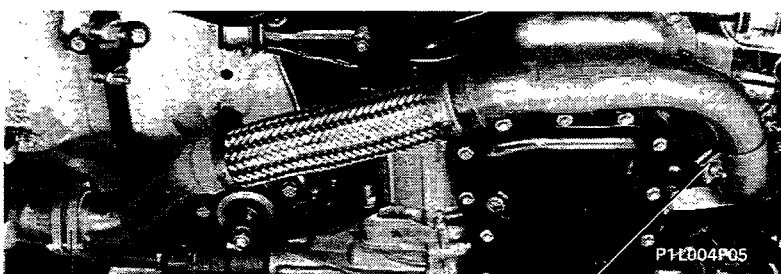
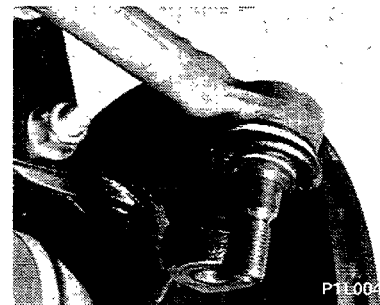
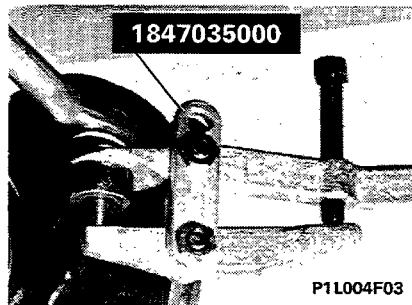
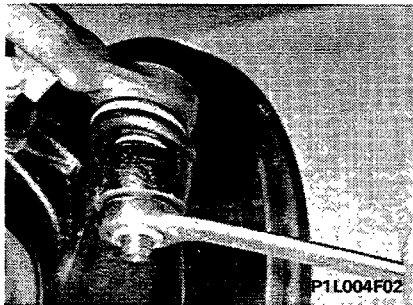
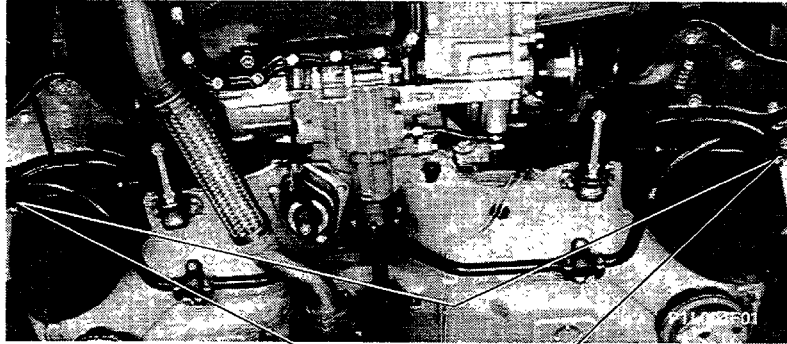

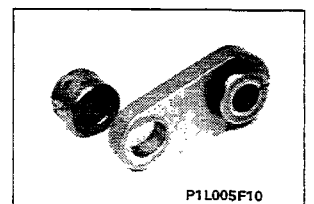
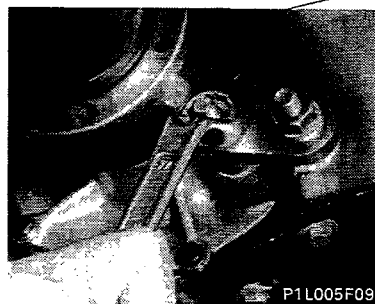
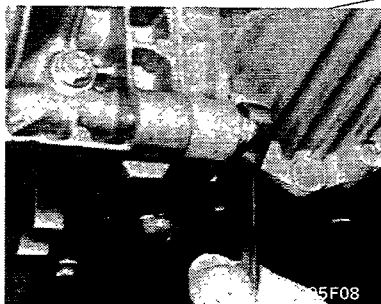
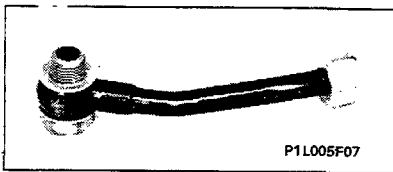
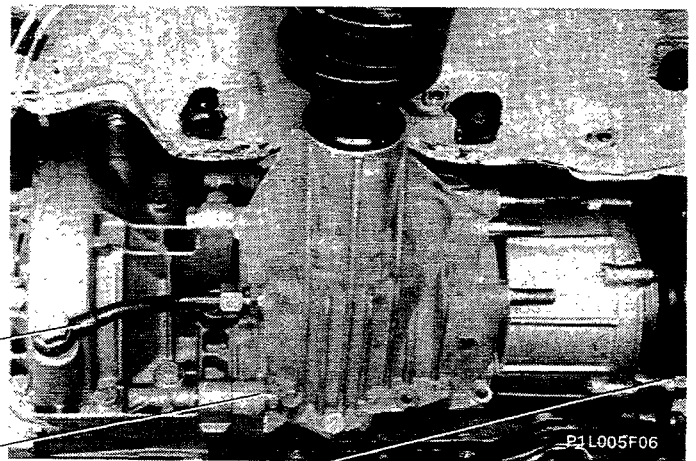
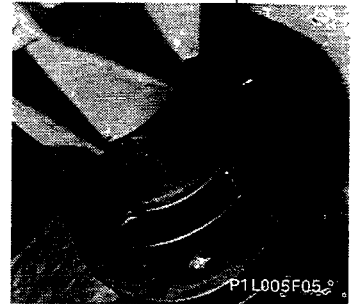
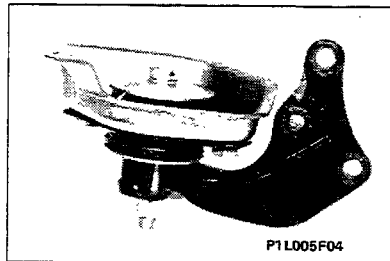
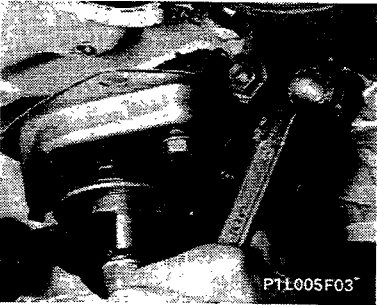
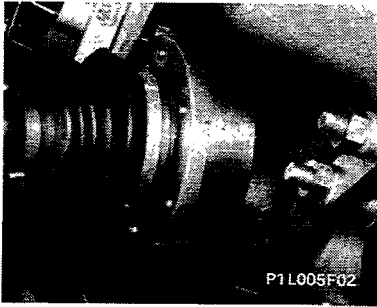
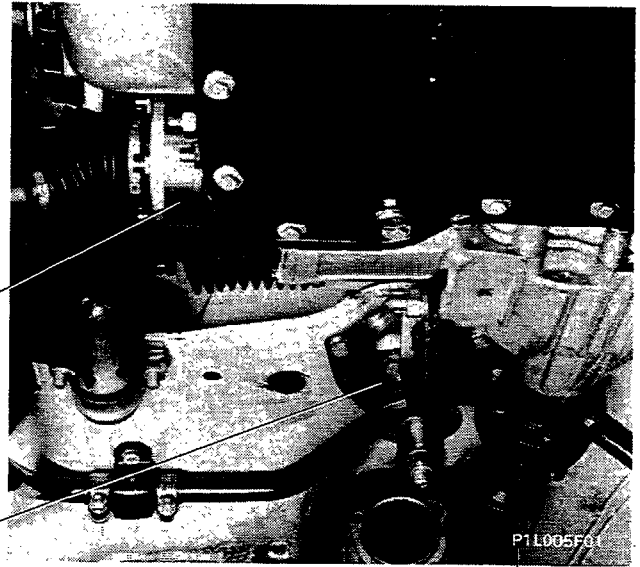

Steering

Power assisted steering box

DELTA-PRISMA 4WD

41.

- position the hydraulic jack under the idler unit;
- then, remove the items illustrated below:

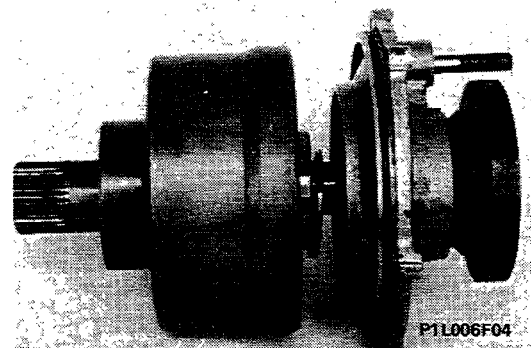
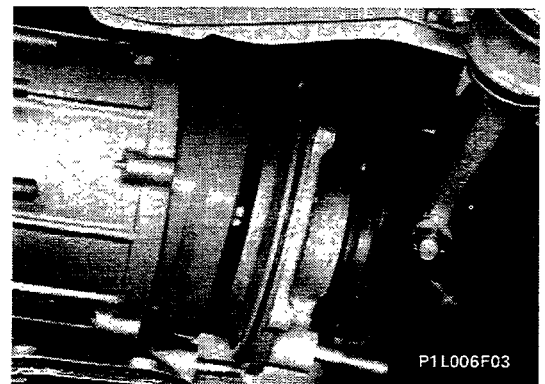
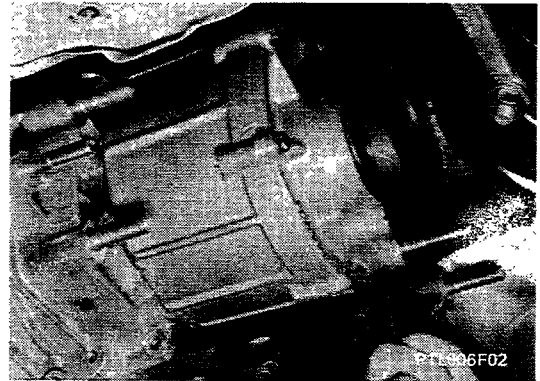
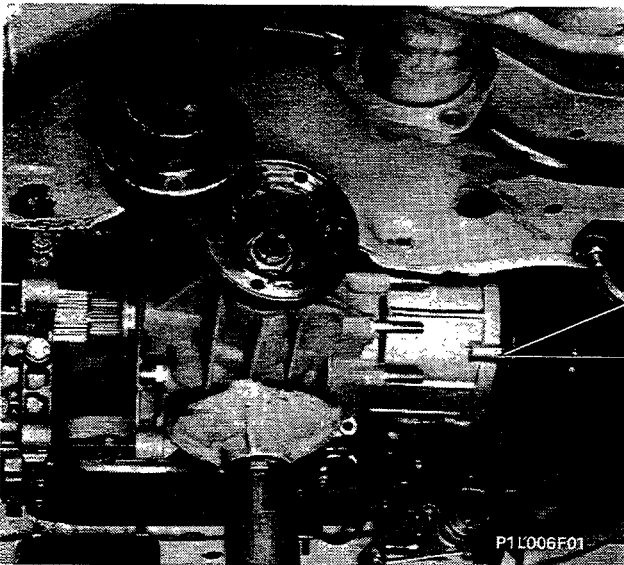

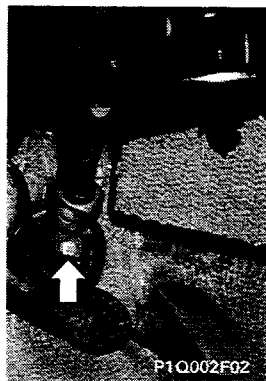
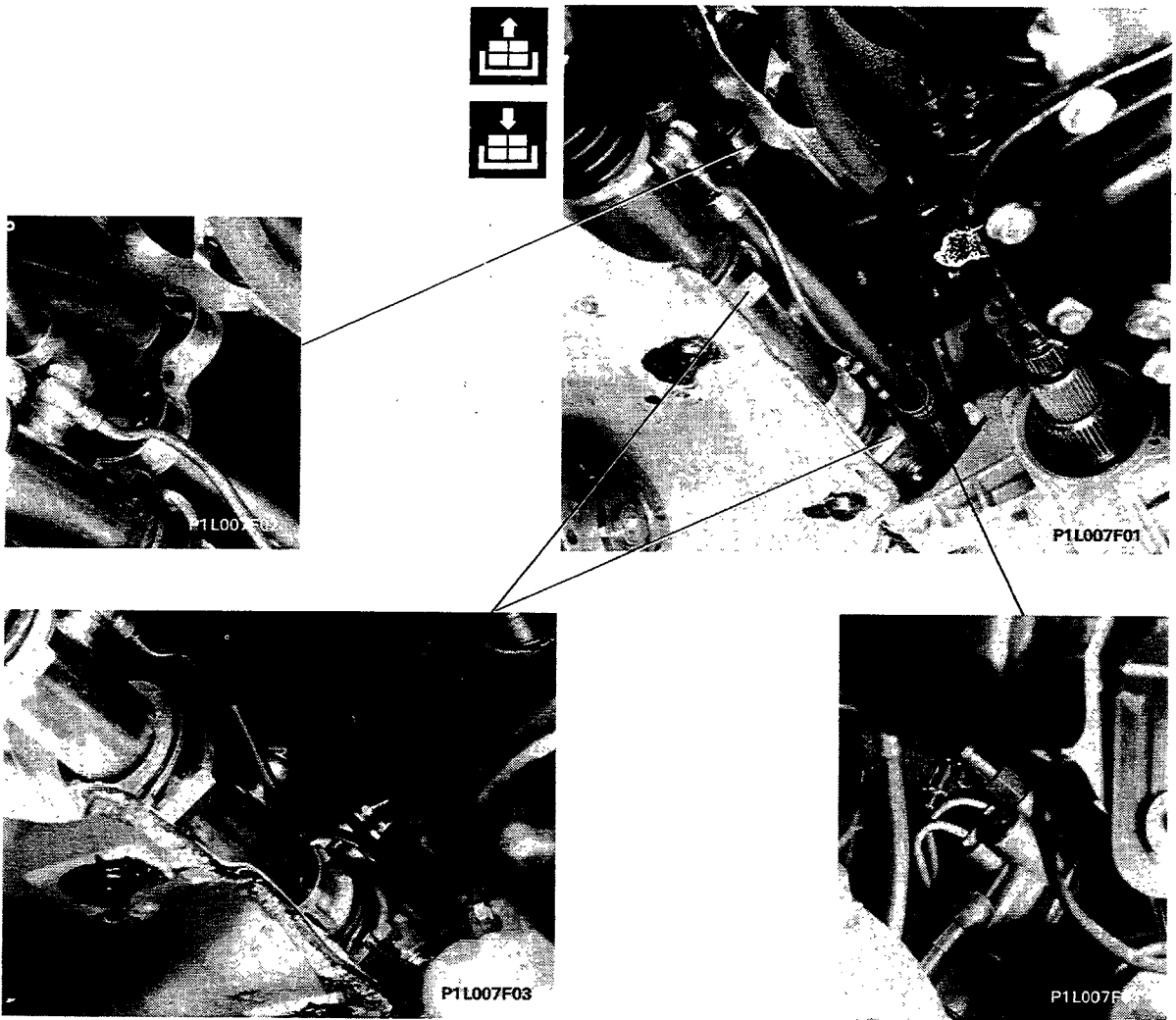

- from inside the vehicle, disconnect the upper shaft from the lower one

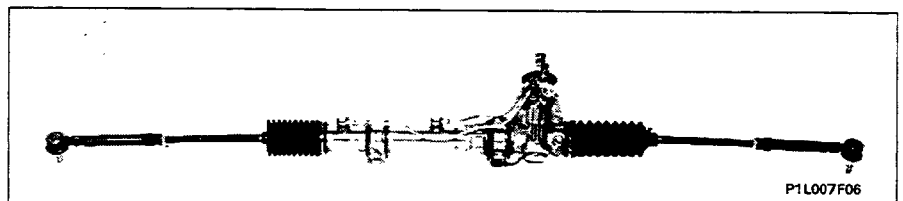

41.

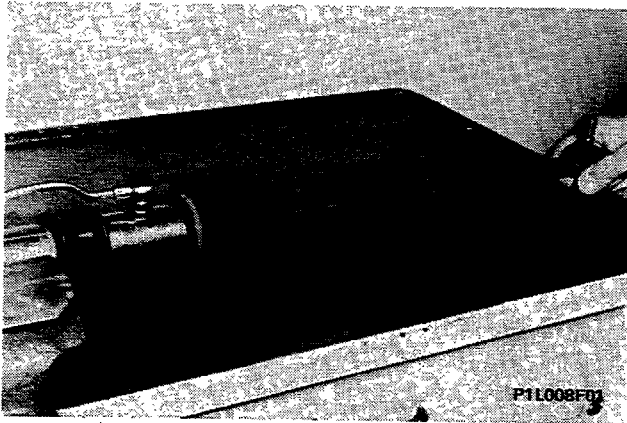

DISMANTLING-REASSEMBLING AND CHECKS



Dismantling-reassembling rod complete with track rod end

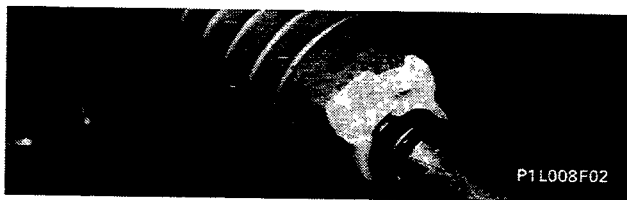

Dismantling-reassembling protective boot and lubricating seal

Before removing the protective boot the plastic collar has to be removed.



Rod complete with track rod end

Check that the track rod end shows no signs of hardening or excess clearance or else it has to be replaced.

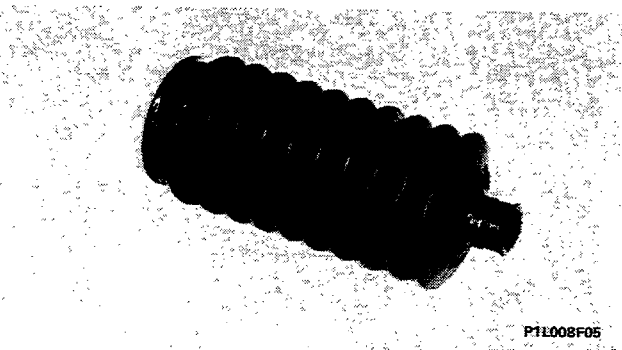

Protective boot

Check carefully that there are no holes or tears in the boot or else it must be replaced.



Before fitting the last boot (pinion side), apply the recommended amount of grease.

COMPOSITION AND OPERATION

The power assisted steering system comprises:

- a supply reservoir located in the engine compartment;
- a vane type pump, driven by the engine with a maximum capacity and pressure valve;
- a set of pipes connecting the pump - distributor valve - operating cylinder - reservoir;
- a rack and pinion hydraulic steering box.

Power assisted steering components

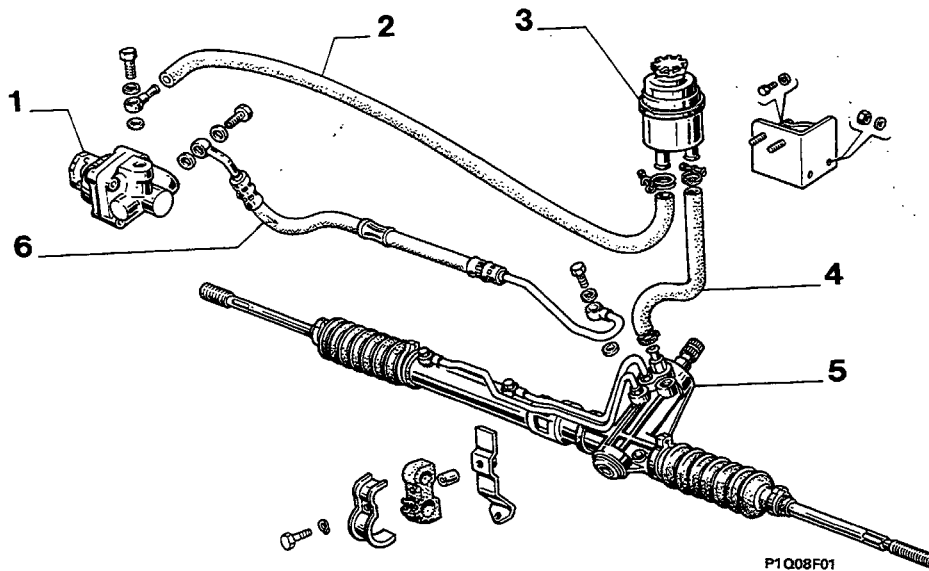

1. Pump
2. Pipe supplying oil to the pump
3. Reservoir

4. Oil return pipe from the reservoir
5. Power assisted steering
6. Oil under pressure supply pipe

Power assisted steering pump components

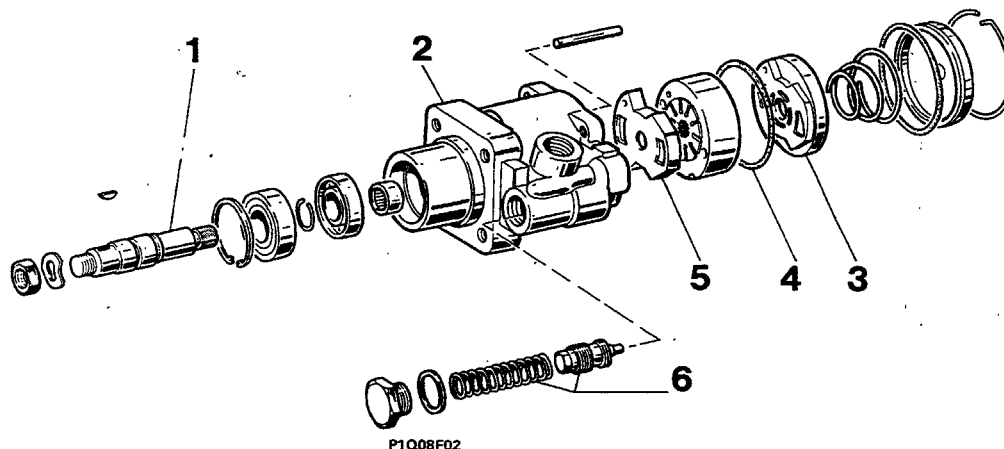

1. Control shaft
2. Pump casing
3. Impeller

4. Seal
5. Impeller side plate
6. Adjustment valve

41.

Power assisted steering distributor valve

The power assisted steering pump is operated by the engine through a belt and is capable of supplying a pressure which varies from 3.5 bar in the "neutral" position to a maximum of 85 bar in the "full steering" position.

In addition, there is also a fast idle control valve located in the pump which increases the engine speed when the power assisted steering is working at pressures exceeding 16 bar.

The power assisted steering unit is similar to a mechanical rack and pinion steering box with the exception of the following features:

- there is an operating cylinder (2) in the steering box in which a double acting piston (1) fixed to the rack rod slides;
- there is a distributor valve (3) and ducts located in the worm screw housing. This valve is controlled by a torsion device (4) positioned in the end of the worm screw.

According to the torion trasmitted by the steering wheel to the device, the oil from the pump is sent to the reservoir or to one of the 2 chambers A or B for the operating cylinder.

The force generated by the pressure of the oil on the side surface of the piston causes the movement of the latter and consequently of the rack.

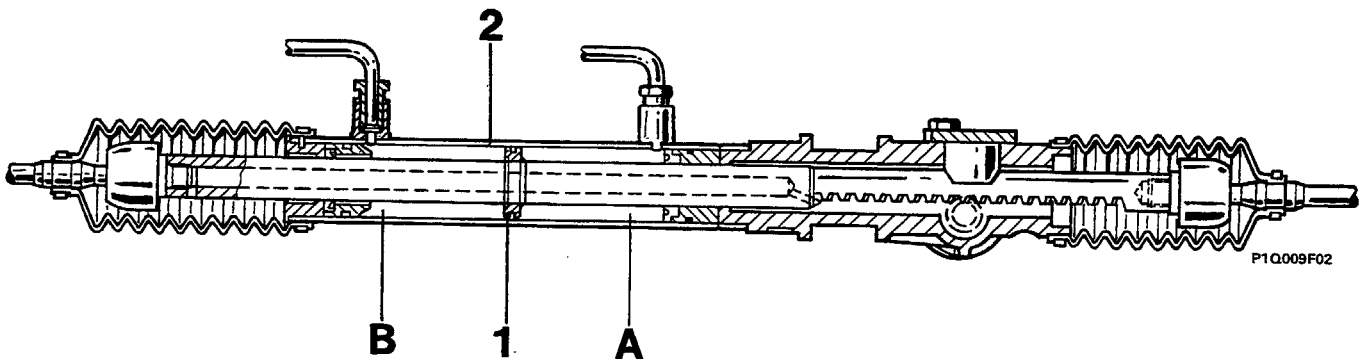
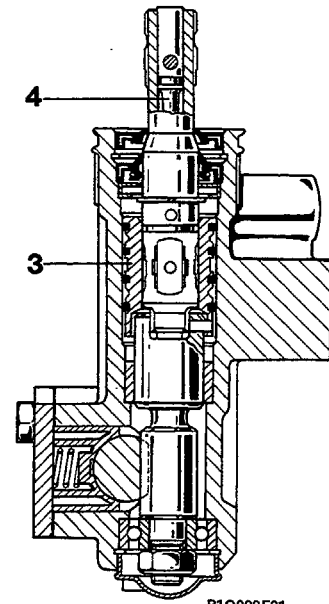

Longitudinal section of rack and pinion power assisted steering

Checking operation

Check the steering wheel rooling torque with the vehicle stationary and the engine running. The torque should be between 0.6 daN with the engine idling and 0.75 daN with the engine at maximum speed; if it exceeds these values, check the pressure of the system with the wheels on full lock. In order to do this, insert a pressure gauge, using a T pipe union, on the tube bringing the oil under pressure to the power assisted steering (from the pump) and turn the steering completely in one direction. Rotate the steering wheel further;; the pressure on the gauge should go up to around 85 bar. If this does not take place, there is a fault in the oil pump or in the power assisted steering valve group.

Check the operation of the pump with the engine running at 1000 - 4000 rpm by squeezing the delivery pipe: if the pressure of around 85 bar is not reached then the pump is faulty and should be replaced.

NOTE *The power assisted steering and the vane pump should not be dismantled for any reason whatsoever but sent to the Manufacturer for overhauling.*

Checking oil level:the oil level should be checked with the engine running, topping up to renew the level if necessary.



The power assisted steering system is self-bleeding; it is achieved by applying full lock alternately to the right and left with the car stationary and the engine running. This operation should be carried out each time the connecting pipes are removed-refitted.

NOTE The hardening of the steering may be due to the pump control pulley belt sliding or to insufficient oil. If the pump or the operating cylinder or the distributor valve is not working properly, then the power assisted steering system will operate like an ordinary, mechanical steering box.

FRONT WHEEL TOE IN

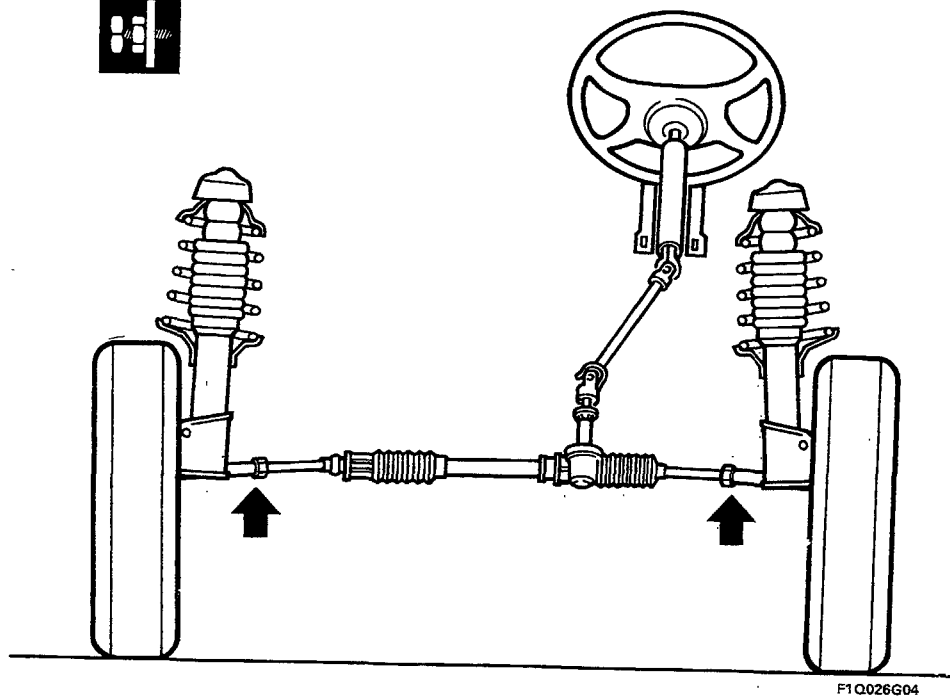

The adjustment of the front wheel toe in is carried out on versions with both mechanical steering boxes and power assisted steering by undoing the nut fixing the rod and tightening or loosening the steering rod until the correct toe in is achieved without altering the position of the steering wheel spokes.

Steering

Tightening torques

DELTA-PRISMA 4WD

41.

| DESCRIPTION | Thread size | Tightening torque |
|---|-------------|-------------------|
| | | daNm |
| Steering wheel to upper section of steering column fixing, nut | M 16 x 1,5 | 5 |
| Steering column support bracket to mounting fixing, bolt | M 6 x 1 | 0,5 |
| Steering column universal joint forks to splined shaft fixing, bolt | M 8 x 1,25 | 2,6 |
| Steering box to bodyshell fixing, bolt | M 8 x 1,25 | 2,1 |
| Steering rod ball joint to steering knuckle lever fixing, nut | M 10 x 1,25 | 3,5 |